

STARVIEW
TECHNOLOGIES
Infinite Possibilities

Private Cloud Made Simple



starviewtech.net



Deliver a connected world-class open infrastructure that is a sustainable ecosystem of compute, network and storage.

Why Starview?

1

Committed Success

Our customer's success is our top priority. We operate a 24/7 support center. You may contact us at +65 6100 DESK (+65 6100 DESK) or email us at support@starviewtech.net or visit our helpdesk at helpdesk.starviewtech.net

2

Flexibility and Choice

Starview partners with industry leaders to help drive innovation across a diverse range of use cases. By collaborating with complementary hardware and software vendors, our customers have more choices than traditional vendor-locked models.

3

One Stop

From consultation to maintenance, Starview will design, build, deploy, and maintain throughout the full life-cycle of equipment.

4

Substantial Value

We can help you reduce TCO of up to 60% (licenses, power & equipment) and deliver high ROI. We are obsessed with your long-term success.

About Starview?

Starview builds high-speed communications infrastructure, and private clouds to power the most demanding workloads. We integrate our Patents and Intellectual Properties of our own products, with third-party solutions to offer unprecedented values and propositions to our customers.

We are passionate about pushing the envelope in technology, harnessing the latest, fastest and best technologies to meet our customer's requirements, and at the same time, breaking the barriers in price and performance.



Scan to
Learn More

2018 SME1000 Turnover Growth Excellence Infocomm&Communications
2018 SG:D Techblazer Awards Most Promising Finalist
2020 Singapore's Fastest Growing Companies

To learn more, visit starviewtech.net

Starview Low Power Transceiver Module @ Data Center

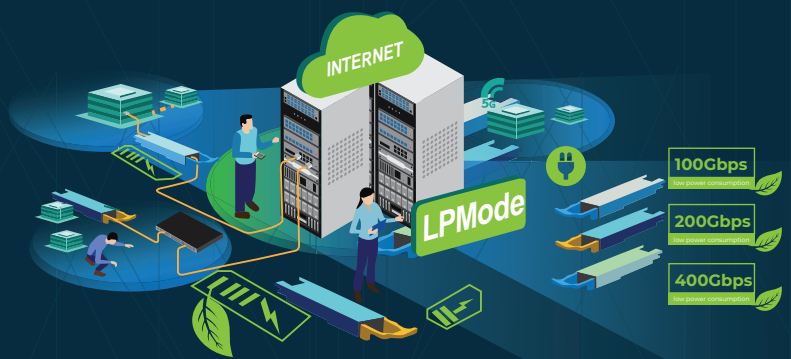

Why Choose STARVIEW Transceivers?

Starview is a reliable supplier of Optical Transceiver modules for more than 10 years, with good customer track records. Starview offers a wide range of transceiver modules, and owns patent for STARPOD (Starview Programmable Optical Device) to program our modules to work in various manufacturer's devices.



Low Power



Cost Saving



Reprogrammable



Multi-Vendor Support



Reliable



Multiple Protocols

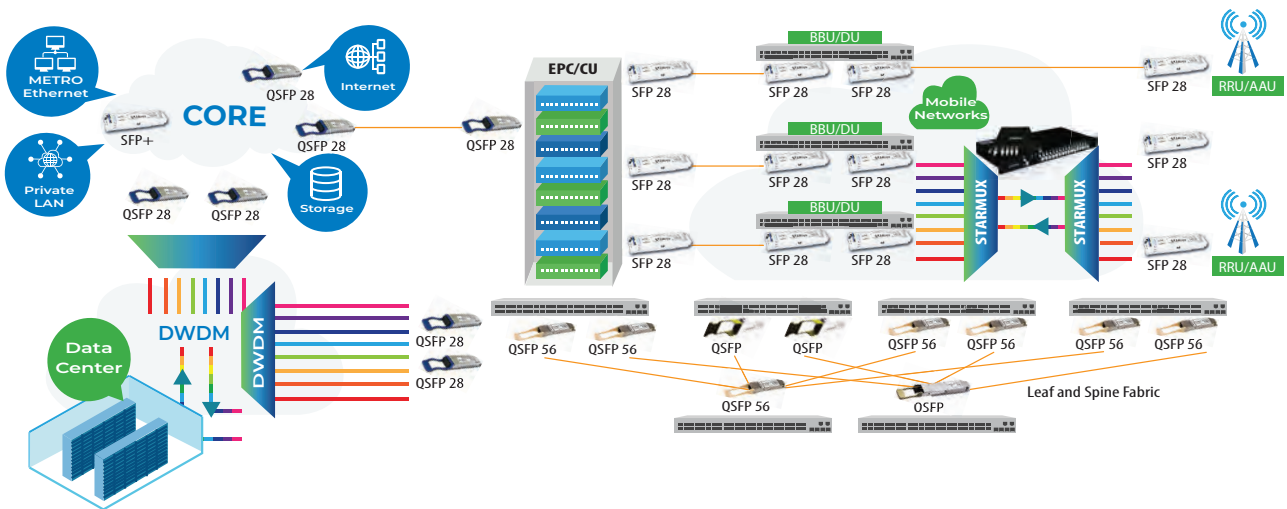

SFP+	SFP28	QSFP+	QSFP28	Single Lambda	QSFP56	QSFP28-DD	QSFP56-DD	OSFP	
5G Wireless Backhaul		40G, 50G & 100G connectivity			200G Transceiver		400G Transceiver		
10G SFP+	25G SFP28	40G QSFP+	50G QSFP+	100G QSFP28	Single Lambda	200G QSFP56	2x100G QSFP28-DD	QSFP56-DD	OSFP
Industrial Temp Dual Fiber LR 10km/20km ER 40km ZR 80km CWDM/DWDM LR 10km/20km ER 40km ZR 80km BIDI LR 10km/20km ER 40km ZR 80km	Industrial Temp Dual Fiber LR 10km/20km ER 40km CWDM LR 10km BIDI LR 10km/20km ER 40km	Dual Fiber SR4 150m/300m LR 2km/10km ER 40km BIDI SR 150m	Dual Fiber LR 10km ER 40km BIDI LR 10km ER 40km	Four channel 4x 25.78Gbps CWDM4 2KM LWDM10/40km SR4 100m LR4 10/20km ER4 40km ZR4 80km	Single Lambda 1x 106.25Gbps DR 500m FR 2km LR 10km CWDM LR 10km	4x53.125Gbps PSR4 100m FR4 2km LR4 10m ER4 40km	8x25.78Gbps 2x CWDM4 2km 2x LR4 10km	8x 53.125Gbps SR8 100m(OM4) 4x 106.25Gbps DR4 500m FR4 2km LR4 10km ER4 40km ZR4 120km / 480km	8x 53.125Gbps SR8 100m(OM4) 4x 106.25Gbps DR4 500m FR4 2km LR4 10km



STARPOD Program Your Transceivers

Patent No: *US 9,959,110 B2 AU 2014395561 SG 11201604256V CN ZL201480074114.9*

Starview Programmable Optical Device (STARPOD) is designed to allow the user to re-program Starview transceiver modules (typically SFP/SFP+ and QSFP+/QSFP28/QSFPP56) in the field. The STARPOD is also capable to tune the DWDM wavelengths of the DWDM tunable SFP+ module. This flexibility to re-program the transceiver module allows the user to connect the module to interwork with multiple leading vendors. The user will save time and money to support the wide varieties of networking equipment today.

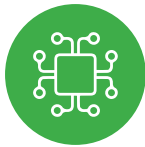

Reprogramming Starview Transceivers



DWDM Wavelength Tuning



Remote Diagnostic

Why STARPOD?

- 1 User friendly interface**
Easy to use menu with click and select interface
- 2 Fast and Efficient**
Immediate use of Starview transceiver to work on device after reprogramming
- 3 Cost Saving**
Saves on CAPEX and OPEX with one common type of transceiver

STARPOD-Purchase VS Transceiver-Purchase

One time Cost:	Purchase price for the STARPOD
Running costs:	None
Suitable from:	...a need of > 50 transceivers per year
Suited for:	...Network Operators, System House, Resellers

One time Cost:	Purchase price for the transceivers
Running costs:	None
Suitable from:	...1 transceivers
Suited for:	...Network Operators, Resellers



STARMUX To learn more, visit starviewtech.net

CWDM/DWDM Mux / Demux

Support multiple network protocols, enabling high speed voice, video and data communications for networking, storage and wireless applications.



STARTAP To learn more, visit starviewtech.net

Fiber Taps

Centralized access to monitor all networks and services. Allow multiple applications access the same network traffic.

Media converters

Patch Panels

Other Accessories

More Products

Scan to Learn More



Starview Maintenance and Support (SMART)

Realizing the value of your technology investments over its lifetime is greatly enhanced with a service partner. Starview offers **SMART** Services.

Dedicated team to support 24x7 through:

Tel: +65 6100 3375 (6100 desk) **Immediate/Urgent attention**

Web: <https://helpdesk.starviewtech.net/portal/en/signin>

Email: support@starviewtech.net

Scan to Learn More



Help Desk

- / Phone, web, email
- / Trouble ticketing system



SLA

- / Spare part guarantee
- / 24 x 7 or 5 x 8 or NBD
- / Custom SLA



Services

- / Multiple-site CPE deployment
- / Testing, Staging, Project Management, Site Survey
- / L2 and L3 TAC



Training

- / Installation, Operation and Maintenance
- / Hands-On
- / Technology Partner



Extended Warranty

- / Back to factory repair
- / Extend manufacturers' warranty (1 -3 yrs)



Preventive Maintenance

- / On-site
- / Hardware & software
- / Half-yearly, or quarterly



Installation & Commissioning

- / 1-stop service material arrangement
- / Configuration
- / Burn-in test
- / 3rd party integration



Shipping & Handling

- / Door to door delivery
- / Direct from factory to End Users' location
- / World wide services



Explore the various solutions and discover how STARVIEW delivers for your business needs.

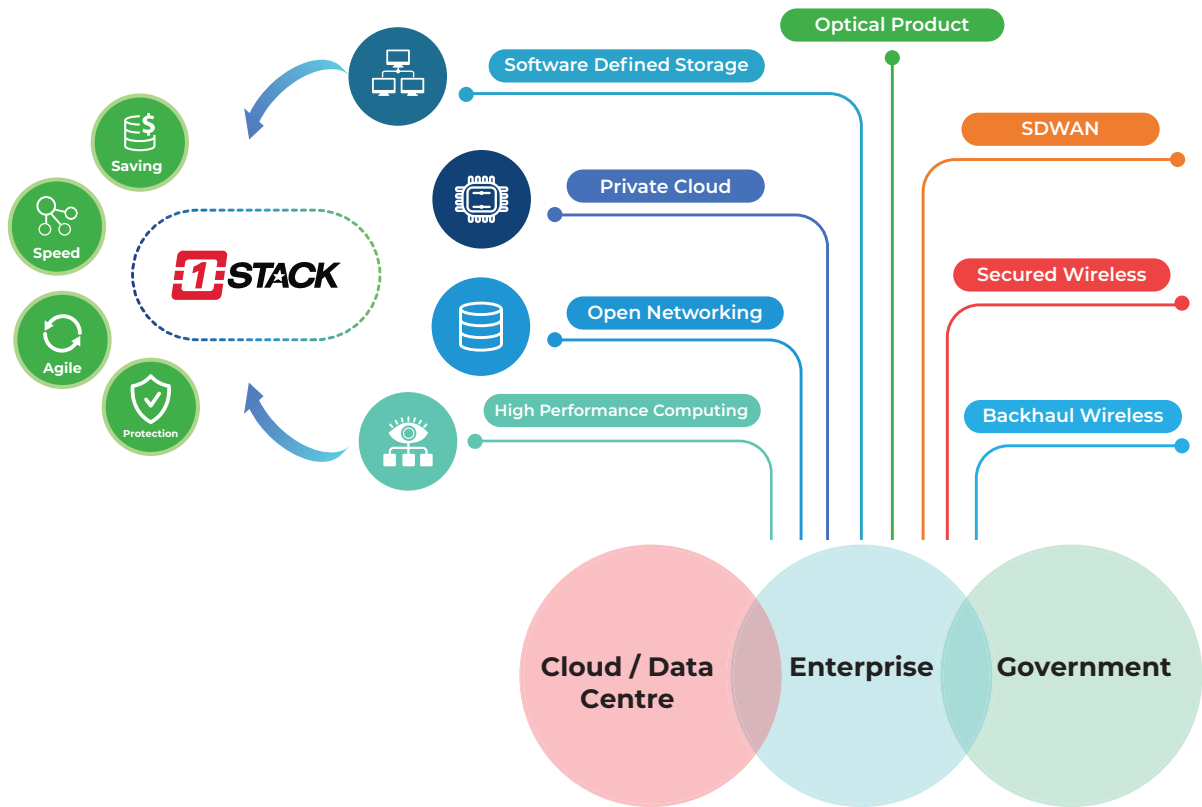

Technology Partners

Starview partners with industry leaders to help drive innovation across a diverse range of use cases. By collaborating with complementary hardware and software vendors, our customers have more choices than traditional vendor-locked models.



1STACK Solves Your Toughest Cloud Challenges

1STACK is an enterprise ready, viable alternative for private clouds. It is derived from Open-Stack, a Cloud Operating System that delivers outstanding compute, storage and network performance without the premium pricing or the licensing lock ins.

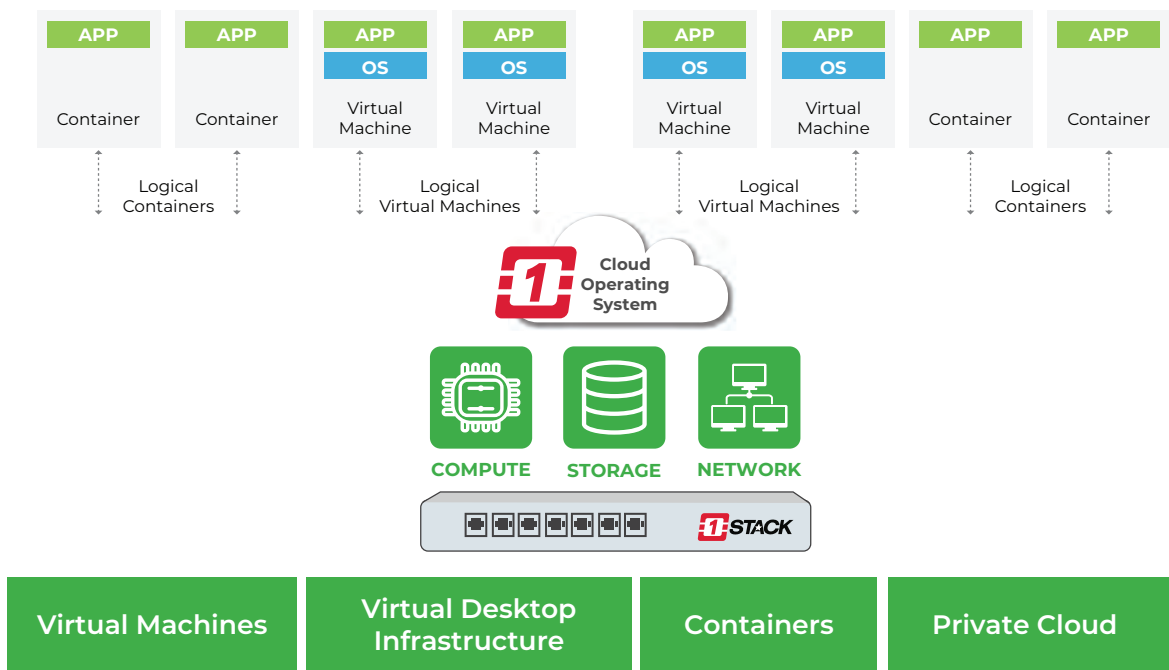

PERFORMANCE

- / Low Latency
- / Availability
- / Enterprise Grade
- / High Speed, Density, IOPs

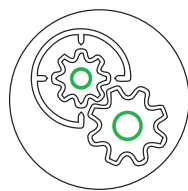

FEATURES

- / Multi Tenancy
- / Fault Tolerant & Resilient
- / Highly customizable



OPEN SYSTEM

- / No Vendor Lock-in
- / Designed for Hyper scale Growth
- / Full modularity



COST

- / Lower Setup Cost
- / Lower Running Cost
- / High ROI
- / Low TCO



ONE STOP

- / Design, Build, Deploy
- / Integrated SW & HW
- / Full Life Cycle Support

Transform Your Business With Starview

Open Networking

Open standard, bare-metal switches allow you to choose the best hardware and match it to the Network Operating System of your choice, whether open-source or commercial.



Your Networks

Break free from proprietary network switches. Adopt the same bare-metal switches used by the world's largest cloud providers, with independent choice of switching hardware and Network Operating Systems.



Software Defined Storage

Software-defined storage (SDS) abstracts storage resources from the underlying physical storage hardware and are therefore more flexible. Programmability enables SDS to scale-out rapidly and automatically adapts to new demands.

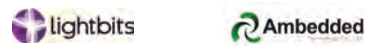

Your Storage

With SDS, you can carve out, provision and extend your storage pools on demand to serve your computing needs at scale. At the same time, you have peace of mind that the data is protected with high availability, uninterrupted access and automated data services.



High Performance Computing

High performance computing (HPC) is the ability to process data and perform complex calculations at very high speeds. With ISTACK cloud-native HPC platform, you get secure, multi-tenant, bare-metal performance for high-throughput applications such as AI, machine learning and data analytics.

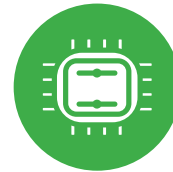

Your Computing

Optimise your servers to run real workloads. Augment your compute with GPUs and DPUs. GPU pooling greatly improves your utilisation of expensive GPU resources, and accelerates your AI/ML workloads. DPU offloads non-compute network related tasks from the CPU.





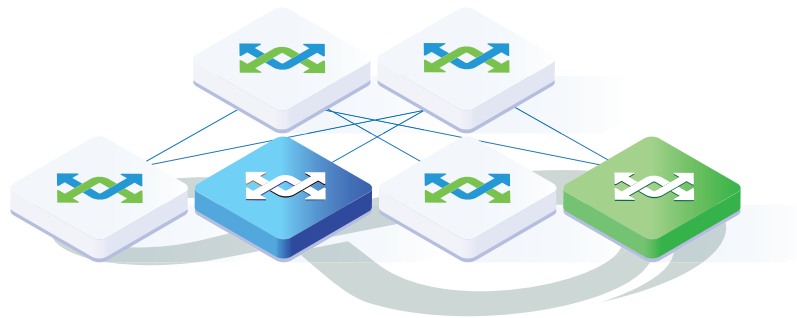

What We Do

Modernize Your Data Center Infrastructure

Build an enterprise private cloud with hyperconverged compute, storage, virtualization, and networking.

Unify All Your Clouds

Effortlessly move apps and data between public, private, and edge clouds for a true hybrid multicloud experience.

Run Any App at Any Scale

Run apps and workloads on a single platform with unparalleled availability, performance, and simplicity.

Explore the various possibilities and discover how 1STACK delivers just what your business needs.

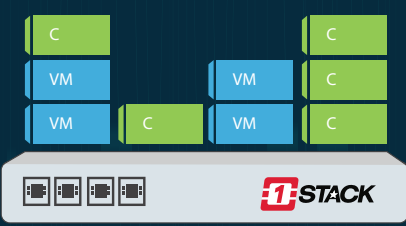

DATA CENTER

- Designed for Hyperscaling
- Based on standard x86 components
- Easily scalable, starting with two 1STACK nodes
- Linearly scale out compute, storage and networking efficiently and independently

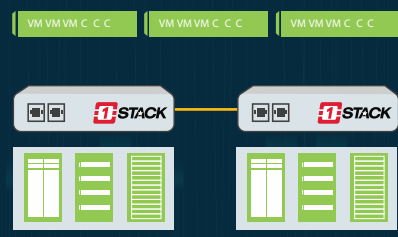

EDGE COMPUTING

- Independent, yet centrally integrated, data services
- Local data processing at edge devices
- Less data to be transmitted over the wire
- Supports remote office / branch office and IoT deployments

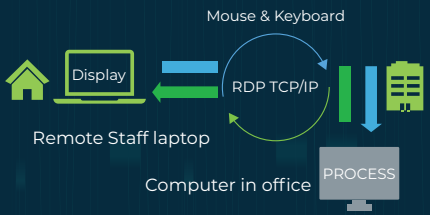

VIRTUAL DESKTOPS

- Improved storage performance for VDI
- Simplify enterprise wide policies for standard desktop environments
- Centralized and simplified desktop support
- Increased security

Cloud Data Center
Media and Entertainment
Network Security
Industrial PC
Surveillance and more



3.6 Petabyte High Density Storage Solution

COMPUTE & STORAGE PLATFORMS
OPTIMIZED FOR ISTACK PRIVATE CLOUD

AIC is a leading provider of both OEM/ODM and COTS (commercial off-the-shelf) and server and storage solutions. With expert in-house design, manufacturing and validation capabilities, AIC's products are highly flexible and configurable. AIC leads the industry since 1996 with experience in mechanical, electronic, system-level engineering as well as a dedication to innovation and customer satisfaction.

Solution Groups

Storage



JBOD storage enclosures with hot swap and modular design features. The JBODs are available in 2U, 3U and 4U form factors, supporting from 12 to 108 drives.

Enclosure



Rackmount chassis for various applications. There are 30 models to choose from. You can also have us modify the chassis or design one from scratch for your project.

Platform



Server hardware features MAX I/O technology which supports maximum PCI express lanes and allows for highly customizable solutions to be created in the shortest possible design period.

JBOD Series

- Hot Swap and Modularized 12G and 24G SAS JBOD Series
- Intelligent Enclosure Management
- Individual drive power management
- Hot swap design for easy maintenance and management
- Enclosure Cable Management Kit
- Tool-less drive trays
- Designed for 1000mm depth rackmount server cabinet
- Tool-less drive trays
- Short-depth
- Clear front panel LED indicators
- Optimized thermal solution
- BMC onboard

Rackmount Storage Chassis

- Tool-less design supports quick installation and easy maintenance:
 - Tool-less 3.5" & 2.5" drive trays
 - Tool-less top covers
 - Tool-less backplane
 - Tool-less slide rails
- 12Gb/s SAS expander chip on backplane
- Specially designed hot swap and low power consumption fans minimize rotational vibration and provide superior cooling
- 3.5" drive tray comes with 4 screw holes to adapt to 2.5" drive
- Comes with a redundant PSU 80+ Platinum
- One front access USB 3.0 port

Hyper-converged Server

- 2U 4-Node hybrid storage server supports 12 hot swap 3.5" SATA/SAS drive bays
- Supports AMD EPYC™ 7003/7002/7001 processor
- Maximizing the use of the numbers of memory, add-on cards and drives in one single system
- Onboard Baseboard Management Controller for system management and IPMI control
- 3 x PCIe x16 extensions on each node
- Front-to-back airflow and easy swap redundant fans to provide optimal thermal conditions

Ceph.

The Future Of Storage

Ceph is the future of storage; where traditional systems fail to deliver, Ceph is designed to excel. Leverage your data for better business decisions and achieve operational excellence through scalable, intelligent, reliable and highly available storage software. Ceph supports object, block and file storage, all in one unified storage system.

With Ceph's adaptability, your cluster will be ready to support all your application and data storage demands, both now and in the future, whether your solution is on-premises, in the public or private cloud, or container native.

Ceph. An unified storage system.

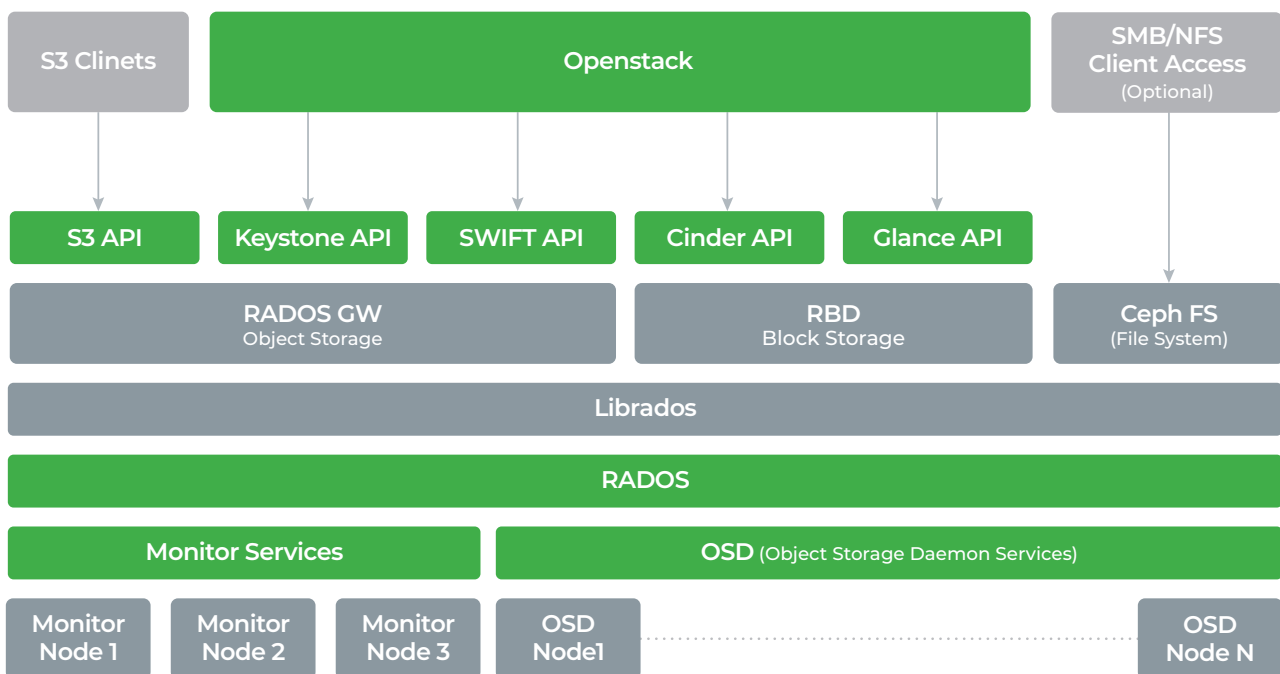

Scalable

Ceph is capable of rapid scaling, without the typical downtime other solutions require. Using the advanced CRUSH algorithm, Ceph overcomes all scalability challenges, leading the way towards truly flexible, incredibly resilient storage at scale. With Ceph, users can stop relying on expensive, vendor-locked in hardware and break free of legacy limitations.

Reliable

With its self-managing and self-healing, Ceph finds and rectifies issues before users are even aware of them. Within your storage cluster, Ceph Monitor and Manager daemons coordinate to increase reliability and data availability across interconnected systems.

Performance

Ceph's configuration and deployment can be completely tailored to your needs, without compromising on performance. Apply Ceph to your existing storage setup, or create a new cluster with widely-available commodity hardware to achieve industry leading reliability and scalability, without the expense of traditional, proprietary ICT infrastructure.

Ambedded Ceph Storage Appliance

A turnkey Ceph storage solution, running on ARM micro-server, saving 60% CapEX and 70% power consumption.

Storage Device

- 8x SATA3 HDD/SSD **OSD**
- 8x SATA3 WAL/DB SSD



8x ARM Quad Core Micro-Server

- 4GB DDR4
- 8G Bytes Flash: System disk
- **5 Gbps** LAN
- **< 5 Watts** power consumption
- Every node can be **OSD, MON, MDS, Gateway**

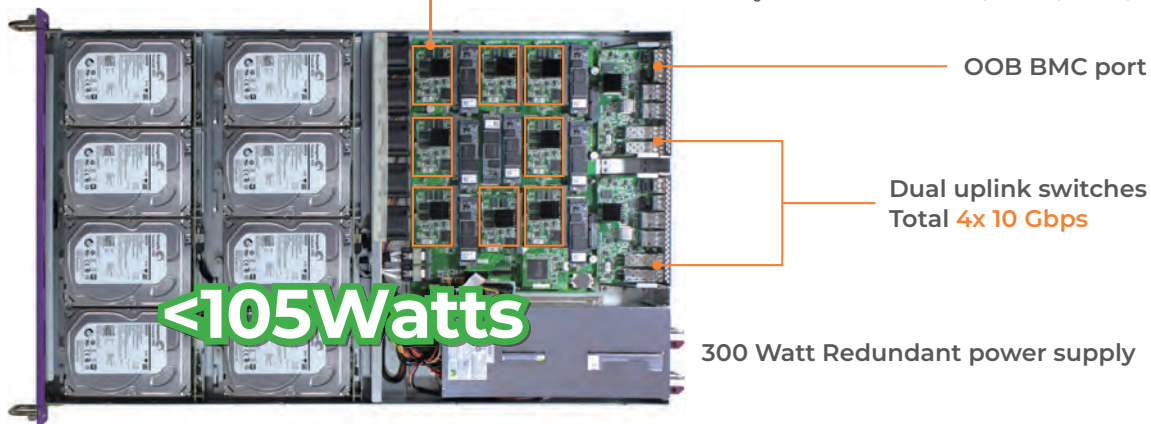







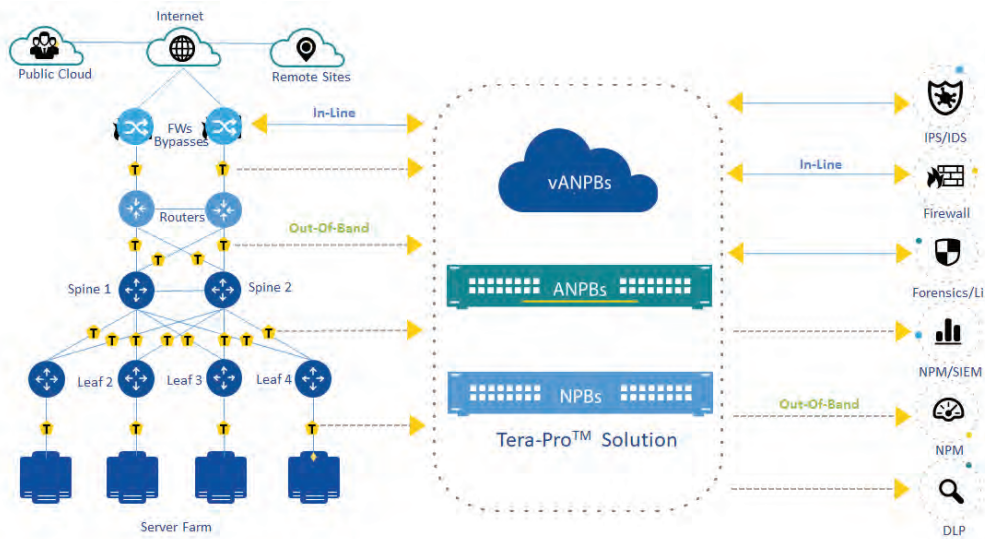

Mars 400 Ceph Storage Appliance Key Features & Data Sheet

Arm server	1U rack mount accommodate 8x nodes Arm 64 server
Processor & Memory	<ul style="list-style-type: none"> ▪ Quad Core Arm A72 v8 servers per node. ▪ Total 32 CPU cores per 1U appliance. 4GB DDR4 per node. Total 32GB per appliance
Node Configuration	Every node can be configured as Ceph monitor, OSD, MDS, RGW or storage gateways
Network Uplink	4x 10Gbps Ethernet ports.
Power consumption	100 Watts at maximum load. (exclude data disks)
Storage protocol	<ul style="list-style-type: none"> ▪ Block storage, CephFS shared file system, S3/SWIFT object storage. ▪ iSCSI, NFS, SMB, FTP, HTTP
Software	<ul style="list-style-type: none"> ▪ Pre-test and tuned Ceph software, Ubuntu LTS, ▪ 3 year free update. Optional extended 2 years.
Storage Device	<ul style="list-style-type: none"> ▪ 8x 3.5"/2.5" top load SATA 6Gbps HDD/SSD ▪ Pre-Installed 8x 120GB M.2 SATA SSD for Ceph OSD bluestore, Docker image and Monitor storage
Management	<ul style="list-style-type: none"> ▪ UniVirStor UVS manager web UI ▪ Ceph command line interface ▪ BMC via ethernet ▪ Prometheus Ceph and node exporter ▪ SNMP
Technical Support	<ul style="list-style-type: none"> ▪ 3 years free Ceph technical support by remote access, ▪ conference call and email. Optional extended support by subscription. ▪ Knowledge base customer portal accounts.

Tera-Pro™ is the most advanced Cybersecurity & Analytics platform currently on the market. A scalable and programmable solution that offloads heavy processing functionality from perimeter devices, ensuring a future proof investment and resilience.

Tera-Pro™ platform is the only future proof platform providing an unrivalled technological edge. Tera-Pro™ is fully embedded within the latest generation COTS hardware, significantly reducing costs and ensuring that you remain a generation ahead of the market. With an outstanding capability to facilitate Terabits of data streams with zero packet loss, Tera-Pro™ enables full GRC capability, ensuring that you are completely secured, always accountable and fully compliant.



 Auto discovery	 Statistics collection	 Bulk operation	 Alarms collection	 Elastic data base	 Graphical dashboards	 Email notifications	 Scheduler for Bulk tasks	 Upgrade manager	 Configuration back-up
--	---	--	---	---	--	---	--	---	---

Network Packet Brokers



- High performance platform with 'Backplane' capacity from 1.4 Tbps up to 25.6 Tbps
- Supporting 10/100/1000M, 1/10/25/40/50/100/200/400G interfaces
- Service/Tool chain for Inline Tools use cases
- Enhanced productivity with Drag & Drop Filter Editor
- Unified management including CLI, SNMP, WEB-UI, Netconf and RESTconf API

Advanced Network Packet Brokers



- From portable up to scalable server-based Packet Broker
- Up to 400G Advanced processing In 1RU space
- Supported interfaces: 10/100/1000M, 1/10/25/40/50/100G

Roealsen5 Series

DapuStor Enterprise NVMe SSD



The DapuStor R5 Series is designed and built on DapuStor DP600 controller firmware with the latest 3D enterprise TLC NAND from KIOXIA. Such a unique combination creates industry-leading SSDs with high speed, superior reliability, low latency, and excellent power efficiency, bringing optimised TCO to enterprise IT and cloud facilities. The DapuStor R5 series is an ideal solution for core data storage scenarios in different fields, such as enterprise IT, logistics, Internet, finance, intelligent manufacturing, and AI.

Industry Mainstream NAND Flash

The DapuStor R5 Series is equipped with the latest 112L 3D NAND Flash from KIOXIA, realising an extremely high-power efficiency. It reduces NAND Retry at the system level through innovative machine learning technologies that predict the NAND workload in complex scenarios to prevent systemic failures.



KIOXIA's BiCS FLASH is a three-dimensional(3D) vertical flash memory cell structure. This structure enables it to surpass the capacity of mainstream 2D (planar) flash memory. KIOXIA's TLC 3-bit-per-cell 512Gb(64GB) BiCS FLASH, an industry first, enhances the reliability of write/erase endurance while boosting write speeds

High storage density per die		Low cost per bit	Less intercell interface
High reliability		Improved power efficiency	High performance

Advanced Features

- Flash Raid 2.0 tolerating multiple flash die failures without affecting service and performance
- Latest NVMe 1.4a key features
- Advanced power loss protection that protects user data against power failure in various scenarios.
- Nine levels of adjustable power consumption: more convenient operation, maintenance, and better TCO.

Computing And Storage Converged Platform

The DapuStor DP600 controller for PCIe 4.0 SSD has a built-in APPLICATION processor and the DPU-Link heterogeneous computing interface. It delivers faster speed when running Linux, conveniently transplants applications and algorithms, and improves system efficiency for database, AI, and big data applications.

SupremeRAID™ When GPU meets NVMe

- **Enhanced storage performance**
 - 10 times write throughput compared with Linux MD
 - 3 times Random IOPs enhancements over Linux MD
 - Industry leading IOPs performance
- **Scalability**
- **Reliability & High Availability**
- **Non-service impacting fast rebuilds**



Graid Technology delivers the next generation of super-fast NVMe-based storage infrastructure. SupremeRAID™, a revolutionary GPU-based RAID technology, delivers the speed, ease of use, flexibility and TCO that market demands for high-performance workloads.

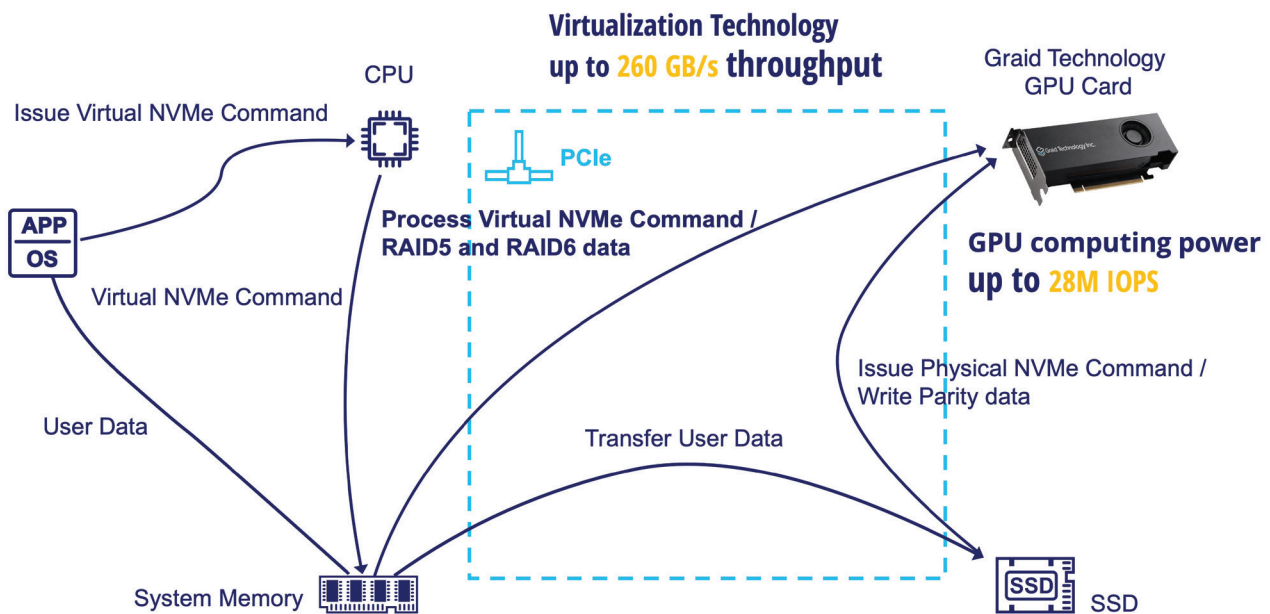

SupremeRAID™ : The Next Generation of NVMe RAID Technology

SupremeRAID™ works by installing a virtual NVMe controller onto the operating system, and integrating a high-performance Nvidia-based GPU to handle all RAID operations of the virtual NVMe controller.

This setup offers many advantages:

- Takes full advantage of NVMe performance – 6 million random IOPS which is currently the industry leading performance benchmark
- Overcomes many limitations of traditional hardware RAID cards, such as slow performance, and limited PCIe bandwidth
- Plug and play
- Supports NVMeoF for shared storage over Ethernet
- Highly scalable, with future software functions such as compression and encryption

OPEN NETWORKING

E d g e - c o r e
NETWORKS

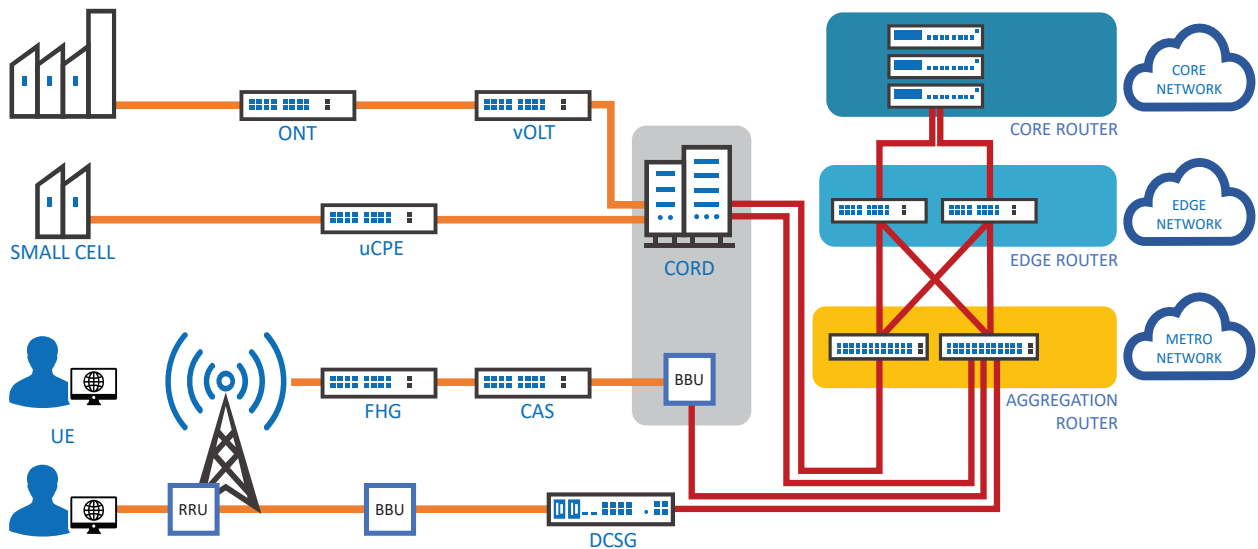
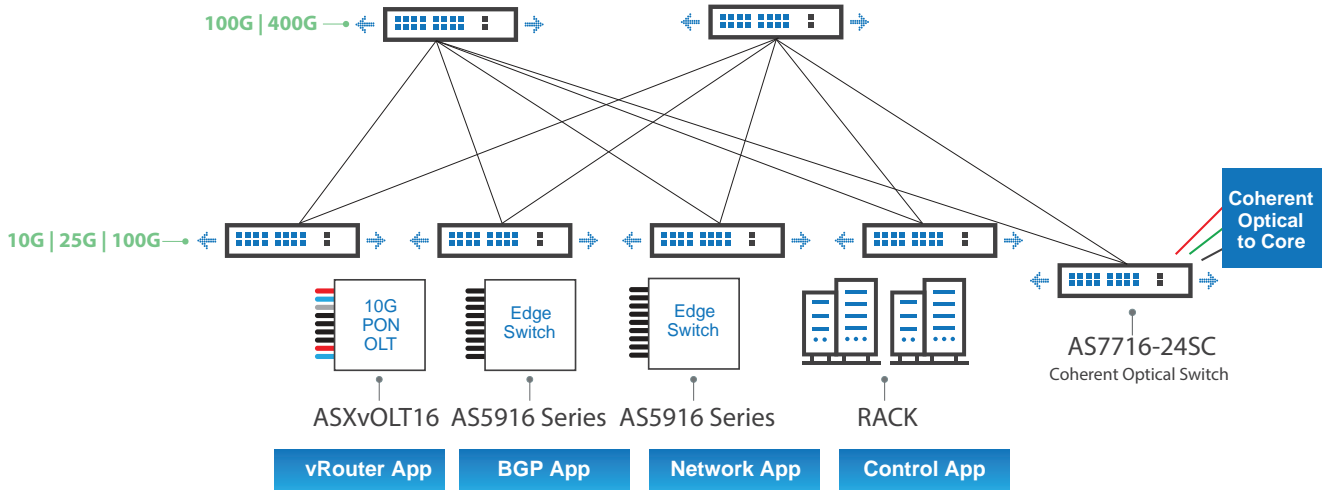

Platinum Level Tiered Membership - Edgcore is OCP Platinum Level Tiered Membership.



Freedom of choice - Edgcore switches support the broadest set of commercial and open source software choices in the industry, providing customers with alternatives to meet their specific requirements.



Greater control - Greater control over the development of enhanced network services, flexibility to work with best-in-class suppliers.



Rapid innovation - Rapid innovation through community and DevOps approach.



Reduced CAPEX and OPEX - Automated and accelerated provisioning of network capacity and services, these open network benefits are now available for many more network use cases, reduced network equipment expenses, and reduced operating expenses.

Open networking solutions are based on open standard, bare-metal hardware with a choice of independent open software for commercial NOS (Network Operating Systems), Open Source Software SDN, virtualization, and cloud orchestration. For years, hyper-scale data center operators have been enjoying the benefits of open networking solutions: reduced network equipment expenses, automated and accelerated provisioning of network capacity and services, greater control over the development of enhanced network services, flexibility to work with best-in-class suppliers, and reduced operating expenses.

These open networking benefits are now available for many more networking use cases. Public and private cloud data centers of all sizes are being deployed with network fabric built from open leaf and spine switches. Edgcore Networks offers choices of hardware to meet open network deployment, from 1G, 10G, 25G and 40G, 100G to 400G.

ENTERPRISE SWITCHES

SWITCHES FOR SMALL/MEDIUM BUSINESS

LAYER 3

L3 switches is designed for enterprise distribution and ISP aggregation to connect the access switch together. High performance hardware based L2 switching and L3 routing for both IPv4 and IPv6 traffic. VRRP were supported for router redundancy. Also, support hardware stacking via 10G SFP+ port and DAC cable, no special stacking module and stacking cable are needed. Multiple switches within the stack can be managed as a single entity with a single IP address, the configuration and firmware can be automatically synchronized.



LAYER 2+ / L3 LITE

Edgecore provides best cost performance L2+/L3 Lite Access/Aggregation switches, helping ISP, MSO worldwide building Fiber to the Building (FTTB), Fiber to the Home (FTTH) infrastructure to provide home users and business users with internet access, IPTV, VoIP, home automation, WiFi hotspot etc services.

Edgecore L2+/L3 Lite Access/Aggregation switches are also ideal for SMB, enterprise, campus networks. The PoE switches provide up to 30W for VoIP phones, Wireless access point, and Surveillance camera. The high power model even supports up to 60W for some PTZ, infrared surveillance camera which required higher power.



INDUSTRIAL SWITCHES

The ECIS4500 series are managed industrial PoE and non-PoE Gigabit Ethernet switches with hardened operating temperature designs. The PoE switches can power any IEEE 802.3af/at-compliant PoE PD devices and include PoE power management features that ease the deployment effort.



WEB-SMART PRO SWITCHES

The Web-Smart Pro series of Gigabit Ethernet (GE) switches with Power over Ethernet (PoE) options is designed for enterprise markets and provides a complete solution from 1G to 10G. As well as IPv4 and IPv6 features, the Web-Smart Pro series supports L3 static routing, QinQ, mDNS and IP Clustering.



WEB-SMART SWITCHES

The Web-Smart series is designed for SMB markets and provides a complete solution with 10/28-ports, including both non-PoE and PoE options. The switches comply with the IEEE 802.3az Energy Efficient Ethernet standard. Support for IPv4 and IPv6. This series offers complete PoE solutions from 70 W to 190 W.



Hystax + 1STACK

Disaster Recovery + Backup
&
Cloud Workload Migration



Disaster Recovery

- Businesses of all sizes face a growing number of risks, from natural disasters and power outages, to human error and cyber-attacks
- Today's business IT infrastructure has become complex and sophisticated, volume of diverse data and workloads is increasing.

Cross-cloud disaster recovery



Relying on a single cloud provider would not be enough to ensure high availability; so, to guarantee 100% uptime, you might want to deploy your workloads in multiple public clouds. Our solution comes to the rescue and restore an access to your data even when one of cloud providers fails.

Why is disaster recovery important?



IT Disasters pose a great threat to any business that relies on IT infrastructure. Just one hour of outage might result in a loss amounting to million dollars. About 75% of disasters are caused by hardware failures or human errors, but their negative impact can be minimized with the help of disaster recovery solutions.

Cloud Workload Migration

- Workload Migration is Complex
- Vendor Lock-In (increasing recurring costs)
- Limited migration experts(enterprise workloads to cloud)

What is cloud migration?



Cloud migration is a process of moving digital business operations from on-premises or legacy infrastructure to a cloud or moving from one cloud to another. It involves migrating your data, applications, and IT processes to data centers and requires a lot of preparatory work and resources. In most cases, cloud migration is worthwhile, as it results in cost savings and higher agility, speed, and operational efficiency.

Starview's Solution (Hystax + 1STACK) to the Problem

Disaster Recovery & Back Up to 1STACK

Cloud Workload Migration to 1STACK



IP Infusion is the leader in disaggregated networking solutions.

Delivers enterprise and carrier-grade software solutions allowing network operators to reduce network costs, increase flexibility, and to deploy new features and services quickly.

The disaggregated networking model allows network operators to build networks with diverse, standards-based hardware and software.



Disaggregation Approach

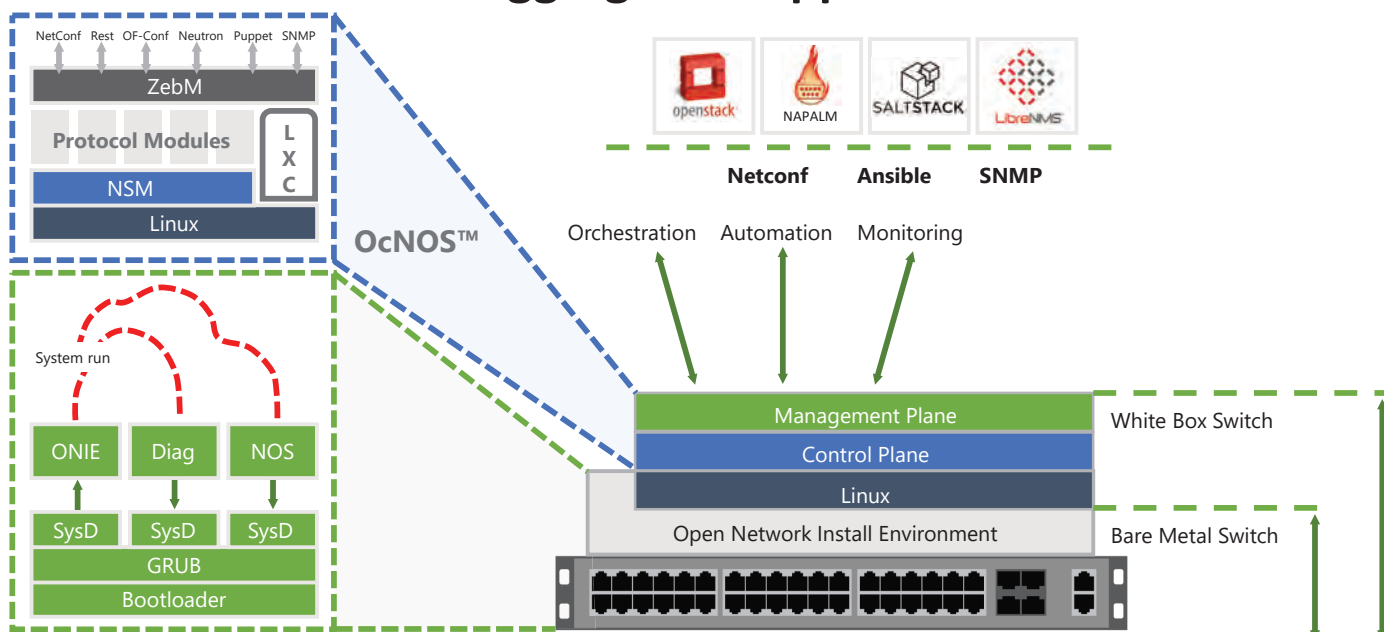

Plug n Play Data Center Network in a Box

- Industry Proven Control Plane
- 24x7x365 Tech Support
- Single Point of Contact
- Your Choice of Whitebox Platform

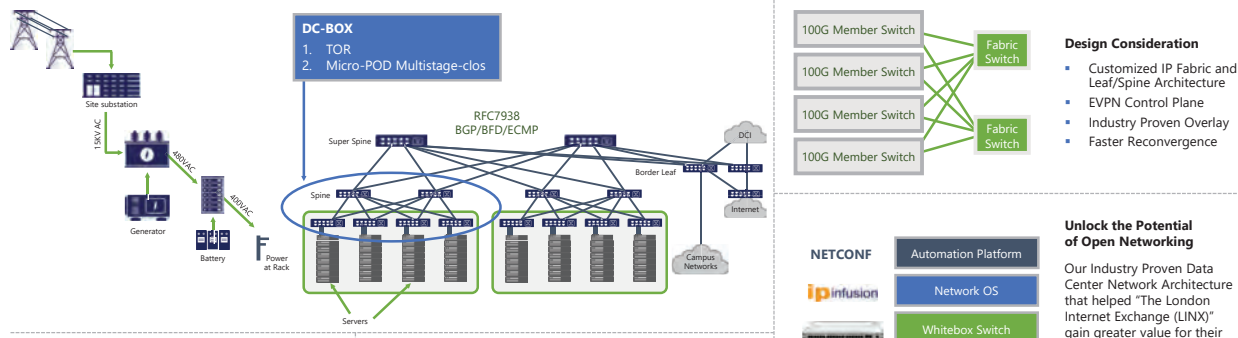

- Design Consideration**
- Customized IP Fabric and Leaf/Spine Architecture
 - EVPN Control Plane
 - Industry Proven Overlay
 - Faster Reconvergence

Unlock the Potential of Open Networking

Our Industry Proven Data Center Network Architecture that helped "The London Internet Exchange (LINX)" gain greater value for their LON2 Network is packaged in DC-BOX.

ipinfusion
Cost Savings: **50%**

OcNOS™
Network Uptime: **99.999%**

When you're responsible for the network that powers your critical services, you need to answer some key questions, fast. Like "Is it the network?" Or "Why are our data costs so high?" Or "Are we being attacked?" You need good answers. With context. As quickly as possible.

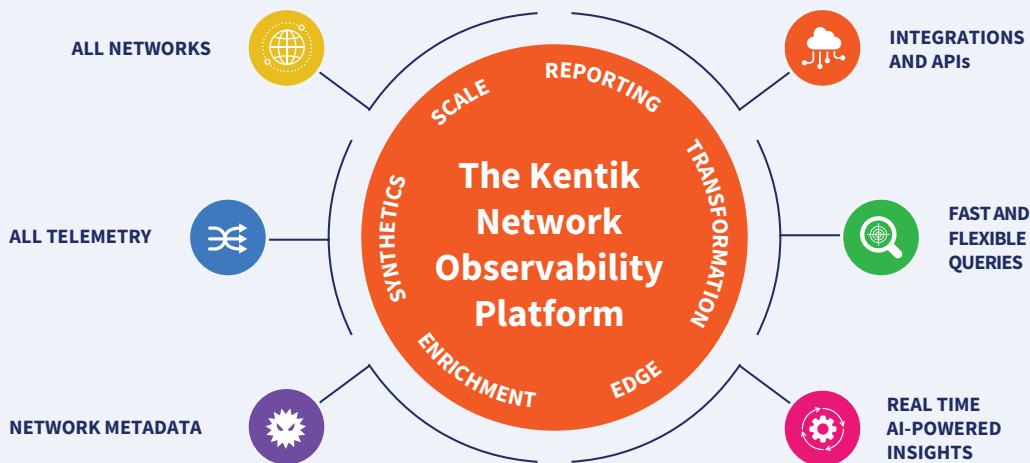
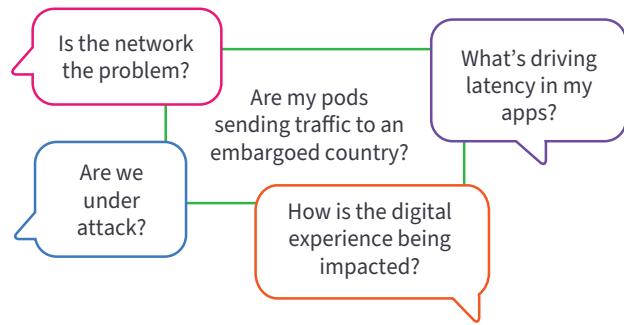

ANY TELEMETRY

POWERFUL ANALYTICS

AUTOMATED INSIGHTS

Kentik is the network observability company. Our platform is a must-have for the network front line, whether digital business, corporate IT, or service provider. Network professionals turn to the Kentik Network Observability Platform to plan, run, and fix any network, relying on our infinite granularity, AI-driven insights, and fast search.

Kentik use cases

Monitor digital experience

Test performance across all infrastructure. Auto-configure synthetic tests based on actual traffic. Detect performance issues. Monitor application transactions and keep tabs on SaaS application performance.

Find and fix problems

Monitor and troubleshoot all networks — corporate, edge, clouds, and internet. See network paths to find issues quickly. Visualize, query, filter, and zoom in to ask any question and get the answer fast.

Manage cloud networks

Monitor complex hybrid and multicloud networks. See traffic to, from, in, and between internet providers, regions, availability zones, VPCs, subnets, Kubernetes pods, and containers. Ensure traffic security and policy adherence.

Secure and mitigate

Protect networks and mitigate security issues. Neutralize DDoS attacks, catch botnets, stop route leaks and BGP hijacking. Analyze forensics and share intelligence with other teams. Track every network participant and traffic flow.

Plan network

Identify optimal transit and peering partners to deliver your services. Understand the applications that traverse your network and their digital supply chain. Accurately forecast capacity needs, and manage utilization of edge resources.

Optimize cost

Tabulate detailed cost metrics based on provider billing and other factors. Make informed decisions to help reduce spend. Easily identify cloud traffic flows that waste money and reduce performance, such as hairpinning and unnecessary egress.

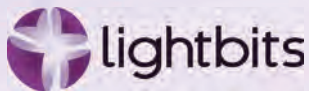

High Performance NVMe/TCP Storage for large enterprise, Telco, Cloud PaaS/IaaS



Lightbits in a Nutshell

Seamlessly move your infrastructure from direct-attached SSDs to a remote low-latency pool of NVMe SSDs

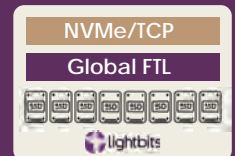

- **Maximize resource utilization** and improve operational efficiency
- **High performance NVMe** storage that Scale with simple & efficient TCP/IP
- **Accelerate data services** – Compression/Erasure Coding/OoS..
- Improving NVMe SSD endurance ie reduce TCO
- **Build a cloud-optimized solution** with API software defined and provisioning
- Multi-tenants for large scale cloud

Value - SaaS, Database Deployment Use Case

40% Reduced storage spend on high performance tier
35% Savings in Ops with improved service availability



Lightbits Solves Your Infrastructure Pain Points

- | | | |
|--|--|---|
| <ul style="list-style-type: none"> • Limited storage capacity in my compute host • I cannot scale storage without compute • I have too many SKUs • My admin/server ratio is too high • I pay too much for SSDs • My TCO is too high with proprietary appliance | | <ul style="list-style-type: none"> • Disaggregate storage with existing TCP networks • Scale storage and compute independently • One storage SKU with linear capacity growth • API-driven management & EC for fail-safe in place • High SSDs endurance, thin provision & compress • Lightbits reduces your TCO by standard hardware |
|--|--|---|

Lightbits SuperSSD™

Fully Integrated NVMe/TCP Appliance

Key Features

- Scalable from 64TB to 192TB capacity
- Very high performance 5M IOPS @4K in 1 SuperSSD appliance
- Plug and Play to TCP network switches
- Fault tolerant
- Wire-speed storage services
 - Compression / Decompression
 - Thin Provisioning
- Composable Storage
- Protocol: NVMe™/TCP
- Connectivity: Dual 100GbE ; wide range of switch vendors support – Cisco, Arista, Mellanox, Dell
- Form Factor: 2U Standard Rack Server
- Availability: Now



High Reliability Backhaul – 1 Gbps+



- 1+ Gbps
- GPS sync
- IP67
- 2x2 DualLink



Product	B5-DualLink Integrated	B5c-DualLink Connectorized	B11-Licensed Reliability	B24-Uncensored Integrated
Features	Short to Mid-Haul • Up to 10 km with twist-on antennas Collocation • Integrated RF shroud + GPS sync Flexible Bandwidth • Dynamic or TDD	Long-Haul • Tower sector deployments Customize • Flexible panel/shield options Collocation • AP channel reuse via GPS sync	Licensed Long Haul • 50 km+ Flexible Bandwidth • Dynamic up/down traffic Low Latency • 1 ms	Short-Haul • Up to 3 km Compact • Small form factor (250 mm, 6 lbs) Resilient • Auto Interference Mitigation
	4.9-6.4 GHz	4950-6200 MHz	10.0-11.7 GHz	24.00-24.25 GHz

Cost-Effective Backhaul – 700 Mbps+

- 700+ Mbps
- IP55
- 1 ms latency



Product	C5c-Connectorized PTP	C5x Family-Simple PTP Link	C6x OFDMA PTMP
Features	Long-Haul • Customizable antennas Low Latency • 1 ms Affordable • Industry best price performance	Short-Haul to Mid-Haul • Up to 10 km Flexible • Single Radio with Antenna Choices Affordable • Best integrated price performance	Short to Long-Haul • Up to 12+ km with twist-on antennas Subscriber Speeds • 1.75 Gbps, 1024 QAM • 802.11ax Wi-Fi 6E
	4900-6400 MHz	4900-6400 MHz	5.15-6.425 GHz

Access Points

4900-6400 MHz
Spectrum Reuse Synchronization (SRS)

A6 WiFi-6E 8x8

Short to Long-Haul

- Wi-Fi 6E - unparalleled 60 bps/Hz spectral efficiency and high capacity 8x8 multi-user MIMO and OFDMA technologies
- Dense city urban or rural tower location (200+ subscribers)

A5c-Connectorized 4x4

Long-Range GPS-Sync

- Rural, tower long distance
- Collocation and network-wide sync enabling channel reuse

Scalable, Uncensored Multipoint Solutions

- Increased capacity at each site
- Ultra-high client capacity
- Network scalability perfected
- Fiber-fast speeds
- Add subscribers with ease

N5-45 Deployment Models

Long Range High Capacity

N5-45x4

Mimosa A5c

Cost Effective Coverage

N5-45x2

Mimosa A5c

3rd Party Access Point

N5-45x2

3rd Party 2x2 AP

Access Product-Distance Relationships





miConverter[®]
Unmanaged Miniature
Ethernet Media Converters



FlexPoint[™]
Unmanaged Compact Ethernet
T1/E1 and Serial Media Converters



iConverter[®]
Managed Media Converters, NIDs
CWDM and T1/E1 Multiplexers



OmniConverter[®]
PoE/PoE+/HPoE/60W & 100W Switches
Media Converters and Extenders



RuggedNet[®]
Industrial PoE/PoE+/HPoE/60W & 100W
Industrial PoE Switches & Extenders

Enterprise Applications

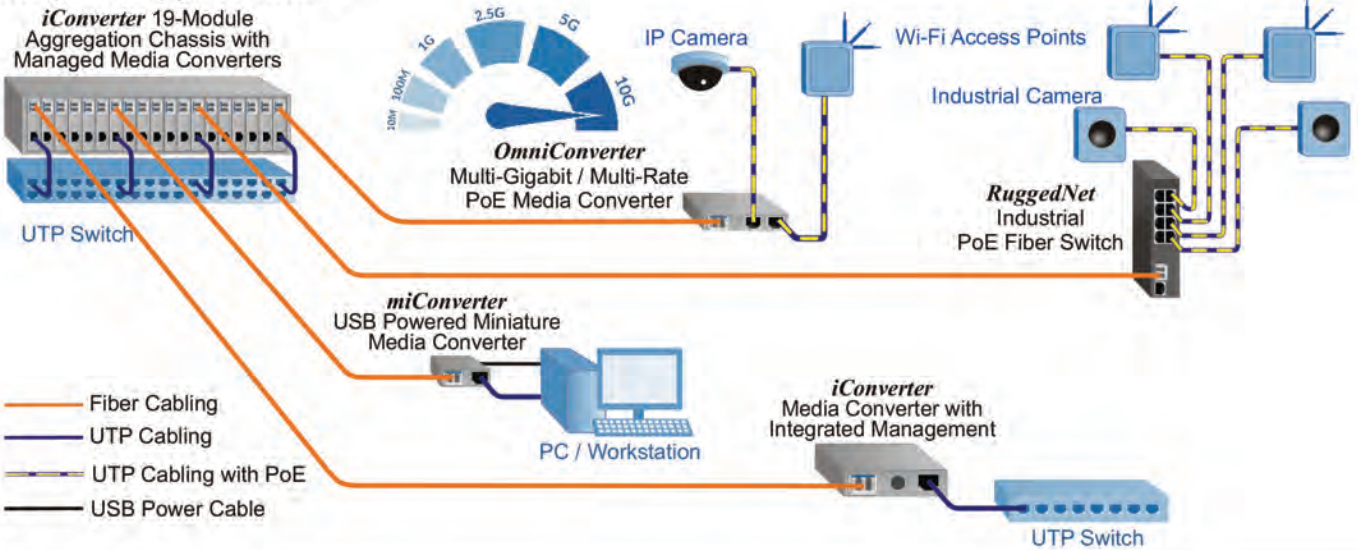

Telecom Applications

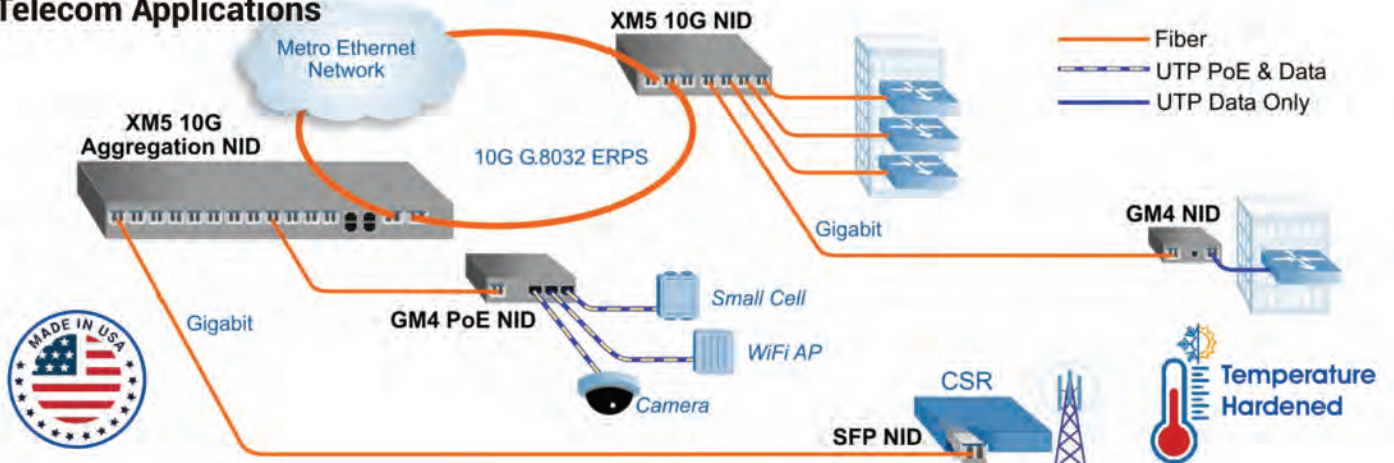

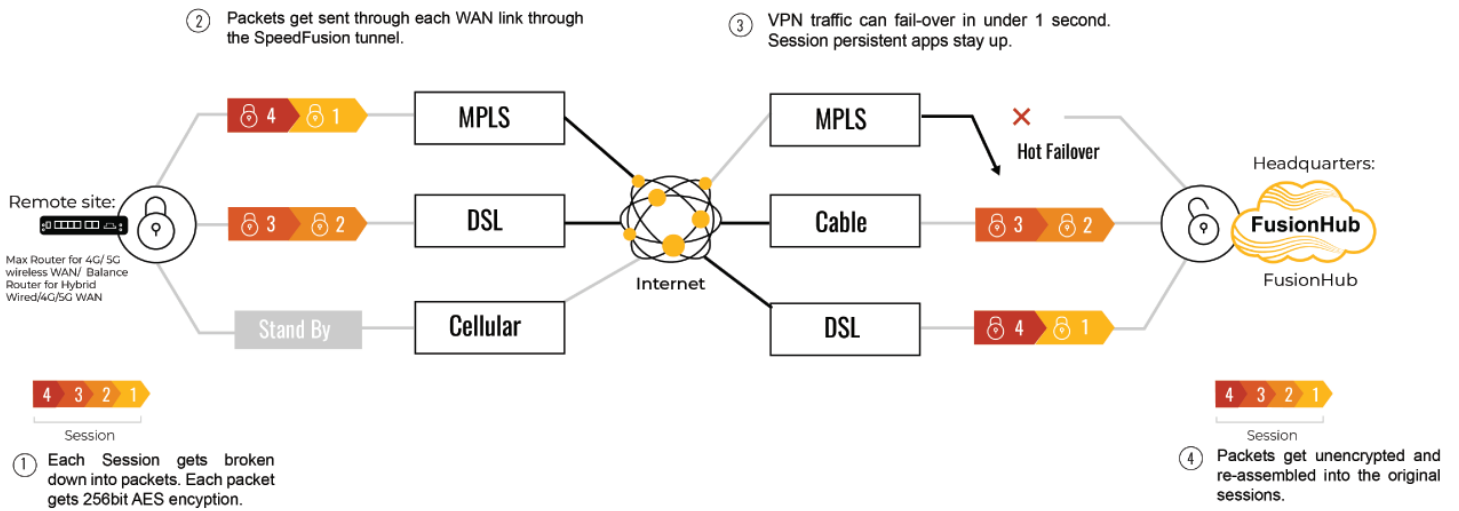

Main Technologies

Hot Failover

In the event of a WAN disconnection, Hot Failover will transfer your traffic to another connection while maintaining session persistence.

WAN Smoothing

Utilizes intelligent algorithms to fill in connectivity gaps ensuring consistent streaming with minimal latency.

Bandwidth Bonding

Combines data at the packet level, enabling you to combine the speed of multiple connections.

Bandwidth Overflow

Monitors network bandwidth usage and switches to the most suitable connection as bandwidth requirements change.



Mission Critical Multi-Cellular Routers

Business Rugged



BR1 Classic
The Original BR1. Still Among The Best.

Outdoor Cellular



HD2 Dome
Dual Cellular. Embedded Antennas. Neat and Simple.



Enterprise Grade Multi-WAN Routers

Branch / Small Offices



Balance 20X 🧑 1-60
• Affordable Link Load Balancing

Small Businesses



Balance 310X 🧑 50-500
• Bandwidth Bonding
• Drop-In Mode, HA

Transportation



BR1 Pro 5G
The Classic Goes Sonic.

Mission Critical



MBX
Quad Cellular Gigabit LTE Mobile Powerhouse.

Mid-Size Businesses



Balance 580X 🧑 300-1K
• Bandwidth Bonding
• Drop-In Mode, HA, LAN Bypass

Large Enterprise/ Campus



Balance EPX 🧑 5K-20K
• Bandwidth Bonding
• Drop-In Mode, HA, LAN Bypass, 10G SFP+ Fiber



5G Product Reliable Connectivity Pioneer



HD1 Dome Pro



BR1 Pro 5G



BR2 Pro



MBX Mini



MBX HD4 5G

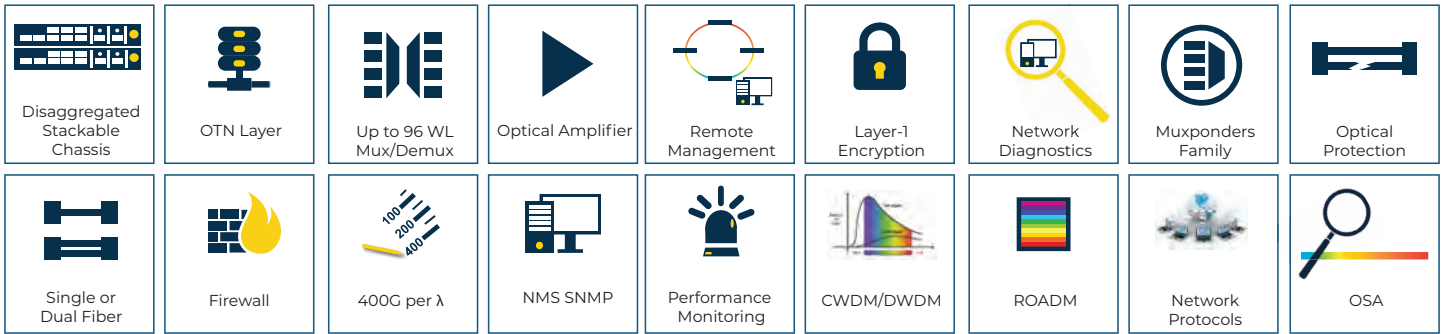

Transponders

Muxponders

Infrastructure

PL-4000T: 4 x 400G Transponder/Muxponder



PL-4000G 4.8T Transponder



PL-2000DC: 4 x 400G Transponder



PL-2000T: 800G Transponder



PL-1000TN: 6 x 8G/10G OTN Services



PL-1000TE: 8 x 1G-16G services



PL-4000M: 400G Muxponder



PL-2000M: 200G Muxponder/Transponder



PL-2000AD: 200G ADM Long Haul



PL-2000ADS: 200G ADM Short Haul



PL-2000: 20G ADM



PL-1000D: Diagnostics



PL-1000RO: WSS ROADM



PL-1000IL: Optical Amplifiers



PL-1000R: Raman Amplifier



PL-300: Passive Solutions



Benefits Overview

- Fiber Optimization
- High wavelength utilization
- Low latency connectivity
- Layer-1 encryption
- Simple to install and configure
- 1U form factor devices
- Network management system
- Integrated mux/demux, EDFA, optical switch, and DCM (optional)
- Pay-as-you-grow architecture

Applications Overview

- Data center interconnect
- Alien wavelength
- Fiber monitoring and diagnostics
- Video transport
- Layer-1 encryption
- Single fiber applications
- DWDM over CWDM
- Multimode fiber solutions

Industries

- Carriers & ISPs
- Dark Fiber Providers
- Utilities
- Research & Education
- Enterprises
- Smart City
- Financial Institutions
- Government & Defens
- Broadcasters

The Leading ICT Infrastructure and Industry Solution Provider

Ruijie Networks, the leading ICT infrastructure and industry solution provider, dedicated to R&D, design, and sale of network devices, network security products, and cloud desktop solutions. Ruijie has been building in-depth scenario-oriented application experience through solution design and innovation in the industry, thus assisting the upgrade into the digitalization of all industries.

With keen insights into customer needs, accurate grasp of industry trends, relying on strong R&D strength and strong technology accumulation, Ruijie could quickly develop targeted and innovative product solutions, such as switches, wireless and IoT, cloud desktops, routers, network security, IT O&M, smart classrooms, etc.

Campus switches

High-density Large-buffer Core Switch for Cloud Architecture Network

Up to 52 x 10GE ports and 12 x 100GE ports per line card, and up to 416 x 10GE ports and 96 x 100GE ports per switch
Fit for data centers, MANs, campus networks, and scenarios with data centers and campus networks

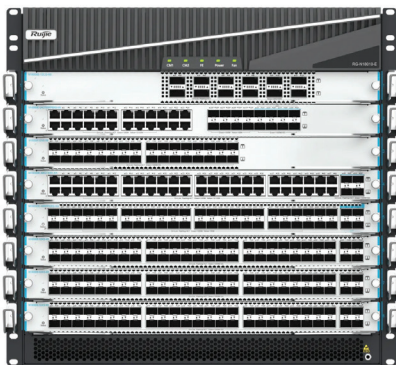

- Clos Architecture, Delivering Non-Blocking Forwarding and High-Speed Transmission Without Packet Loss.
- RGOS, a Fully-Decoupled Modular OS, Providing Independent Components and Nonstop Services.
- Multiple Hardware Protection, Offering Carrier-class Reliability and Ensuring Continuous Operation Without Downtime.
- Fan Connections in In-line Mode and Y-Shaped Airflow, Improving Heat Dissipation and Enhancing System Reliability.
- Supporting SDN, Providing Rapid Deployment and Automated O&M for Campus Networks.

Wireless and IoT products

Wi-Fi Indoor AP with Built-in AI Radio

Indoor high-quality network scenarios in the higher education, medical industry, government and commerce
The 5 Gbps SFP port is designed for Ruijie All-Optical i-Share+ Solution, unleashing the bandwidth performance to achieve ultra-gigabit access. Moreover, one 5 Gbps electrical port is provided for wired connection, maximizing the return on investment (ROI).



- Multi-scenario adaptability, providing flexible solutions to meet diverse service needs
- 5 Gbps SFP combo port for flexible networking
- Seamless client roaming enabled by AI radio
- Real-Time, full-band scanning for a secure network
- 160 MHz high bandwidth, 3.843 Gbps high speed with Wi-Fi 6
- WIS unified cloud management for easy O&M

60 Kaki Bukit Place
#05-19 Eunos Techpark
Singapore 415979
Tel: +65 3157 5338
Fax: +65 6591 8831

For sales and enquires,
Please email to sales@starviewtech.net

For technical support,
Please email to support@starviewtech.net

ver_3

All Rights Reserved © 2022 STARVIEW TECHNOLOGIES

